

CYTY108A (InSb) HALL-EFFECT ELEMENT

Hall-effect element CYTY108A is made of compound semiconductor material indium stibnite (InSb), which utilizes the Hall-effect principle. It can convert a magnetic flux density signal linearly into voltage output.

FEATURES

- High Magnetic Sensitivity
- Low Offset Voltage
- Miniature Package

TYPICAL APPLICATION

- Magnetic Field Measurement
- Current Sensor
- Detection of Speed
- DC Brushless Motor
- Position Control

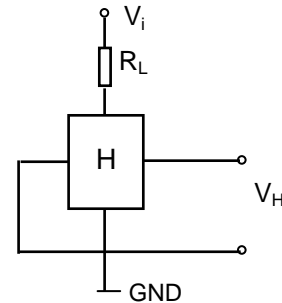

1. Maximum Ratings

(Ta=25°C)

Parameter	Symbol	Rating	Unit
Maximum Input Current	I _{max}	20 (at 25°C)	mA
Maximum Power Dissipation	P _{max}	150 (at 25°C)	mW
Operating Temperature Range	T _{op}	- 40 ~ + 110	°C
Storage Temperature Range	T _{st}	- 40 ~ + 125	°C

2. Electrical Characteristics (Measured at 25°C)

Parameter	Symbol	Measurement Conditions	Min	Max	Unit
Output Hall Voltage	V _H	V _{in} = 1V, B = 50mT	196	415	mV
Input Resistance	R _{in}	I = 0.1mA	240	550	Ω
Output Resistance	R _{out}	I = 0.1mA	240	550	Ω
Offset Voltage	V _O	V _{in} = 1V, B = 0G	- 7	+ 7	mV
Temp. Coeff. of V _H	α	T _a = 0 ~ + 40°C AVG.	-	- 1.8	% /°C
Temp. Coeff. of R _{in} , R _{out}	β	T _a = 0 ~ + 40°C AVG.	-	- 1.8	% /°C
Dielectric strength		100V DC	1.0		MΩ

V_H = V_{HM} - V_O (V_{HM} : The output voltage measured at 500G.)

3. Rank Classification and Mark on Output Hall Voltage

Output Hall Voltage, V _H (mV)	Rank	Measurement Conditions
196 ~ 236	D	V _{in} = 1V, B = 50mT (Constant Voltage)
228 ~ 274	E	
266 ~ 320	F	
310 ~ 370	G*	
360 ~ 415	H*	

*Sensors with rank G and H are custom made sensors

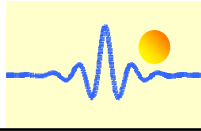

4. CHARACTERISTIC CURVES (only for references)

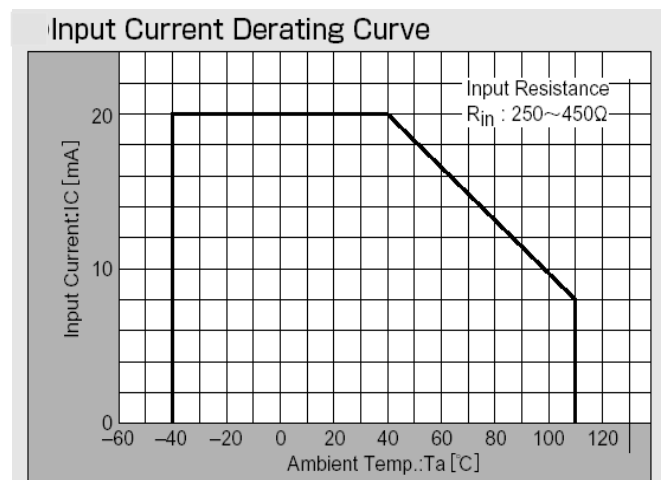
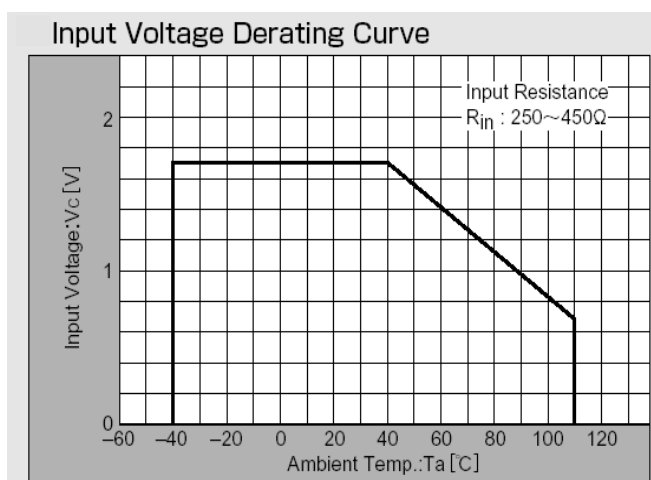
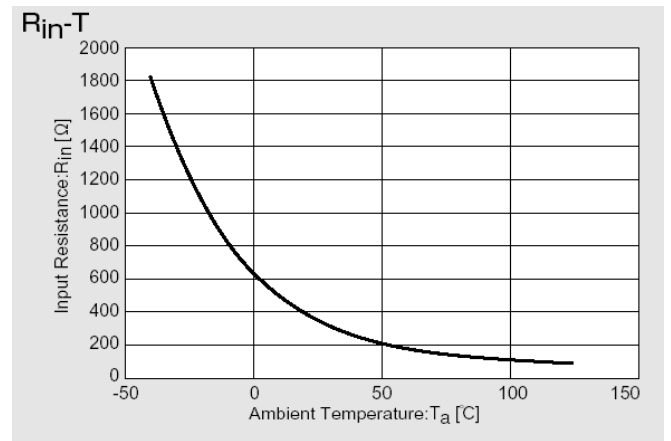
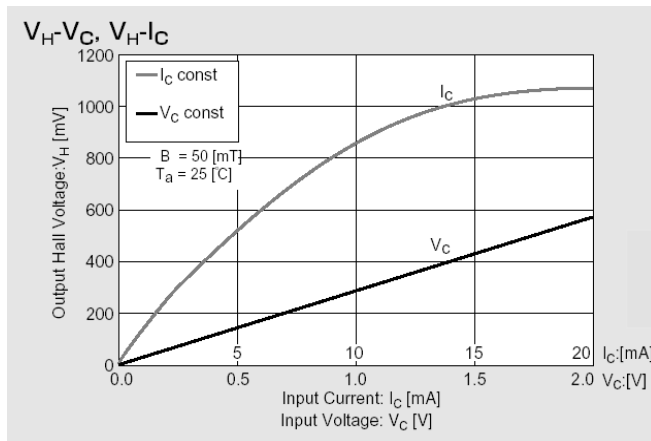
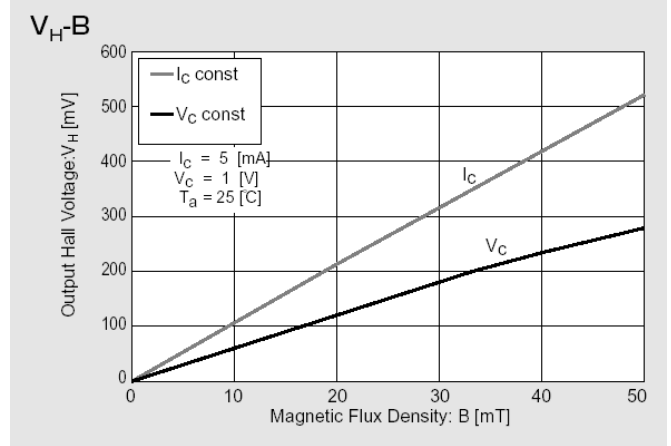
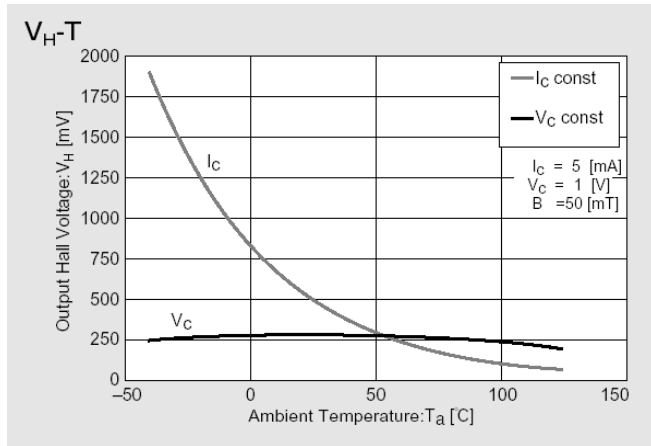

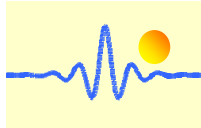

5. Method for Mounting

5-1. Soldering Conditions on PCB

1. No Rapid Heating and Cooling.
2. Recommended Preheating condition is at 130~150°C for 2~3minutes.
3. Recommended Reflowing condition is at 220~230°C for 10~15seconds.

5-2. Soldering Method and Temperature

Items	Methods	Temperature
Reflow	Soldering by Passing the Heated Zone	Max 250°C in 20sec
Solder Iron	Soldering by Soldering Iron	Max 300°C in 3sec

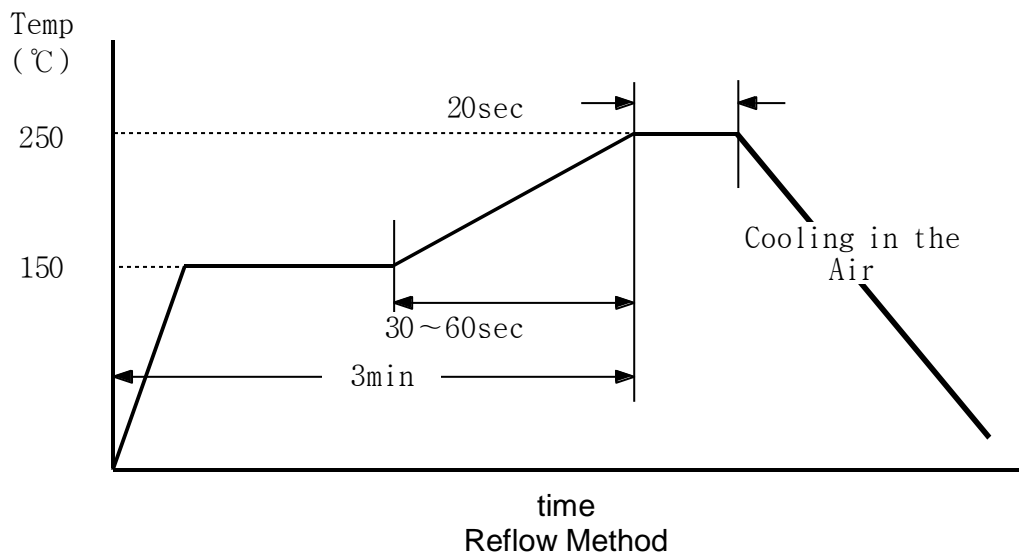

6. Packaging

6-1. Taping

1. CYTY108A should be packed that marked side is viewed from cover tape and long side is put parallel with tape running direction. Making use of it after 180° rotation has no problem because of its symmetric mode.
2. The vacant parts more than 40mm are located at front and end side of the reel.

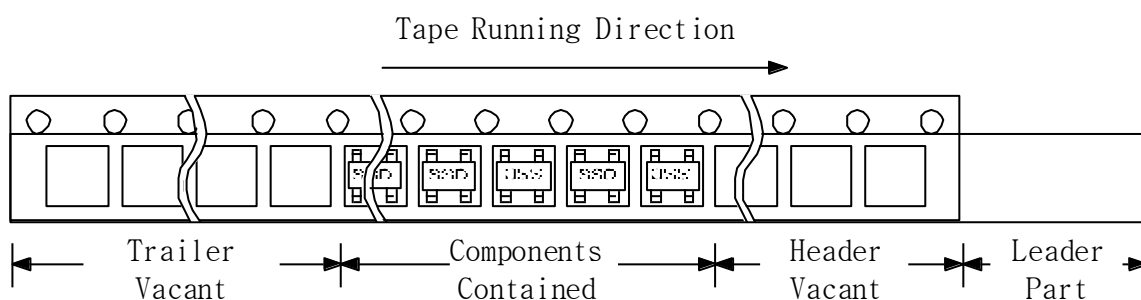

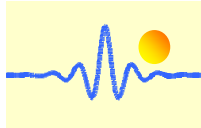

6-2. Tape Specifications

1. Pull Strength(F) = 20~70g

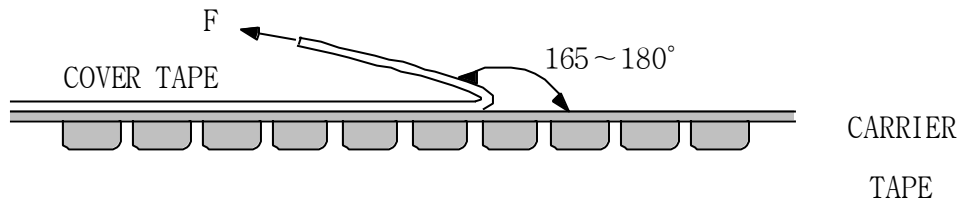

2. Devices should not be flipped out of a pocket when tape is bent down by 15mm curvature.
3. Devices should not be stuck to cover tape.
4. Devices should be kept below 40°C and below RH80% in the shade.
5. Tape has no joint.

6-3. Packing Unit

1. 3,000pcs of devices are packed in one reel.
2. Five reels are packed in one inner box.
3. Four inner boxes, 60,000pcs of devices, are packed in one outer box.
4. Dummy could be packed for safe dealing.

7. External Dimensions (Unit: mm)

Four leads of input and output terminals are designed in the diagonally symmetric mode and are equal in dimensions. Regardless of 180° rotation of Hall sensor, CYTY108A can be used

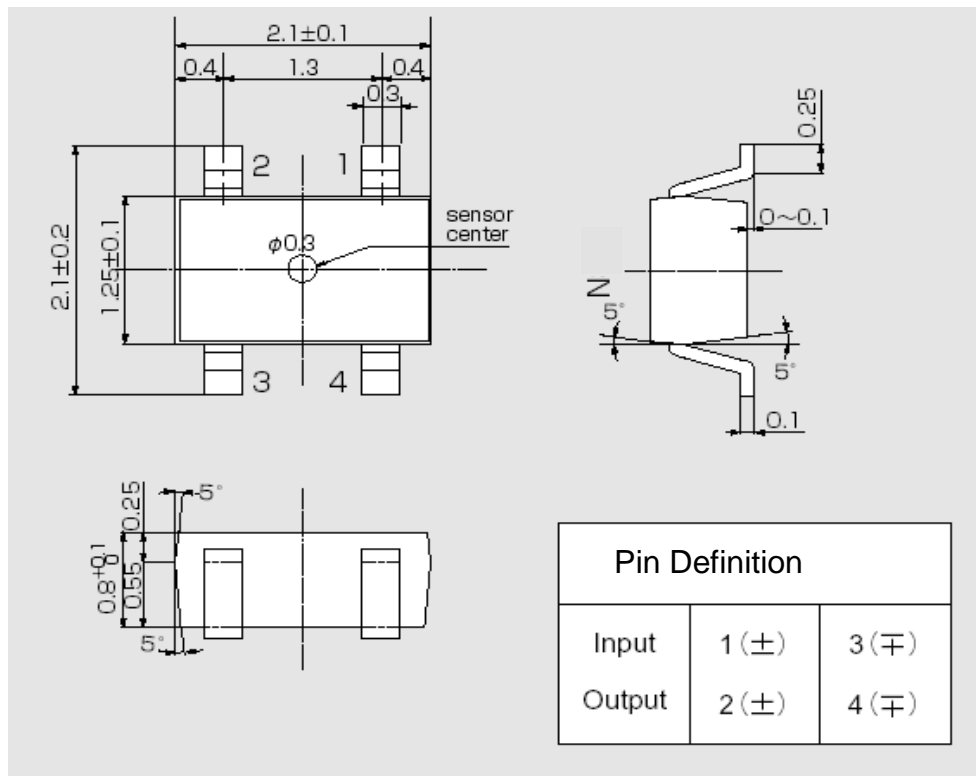

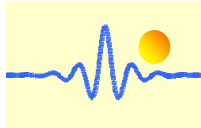

8. External Dimensions of Carrier Tape (Unit: mm)

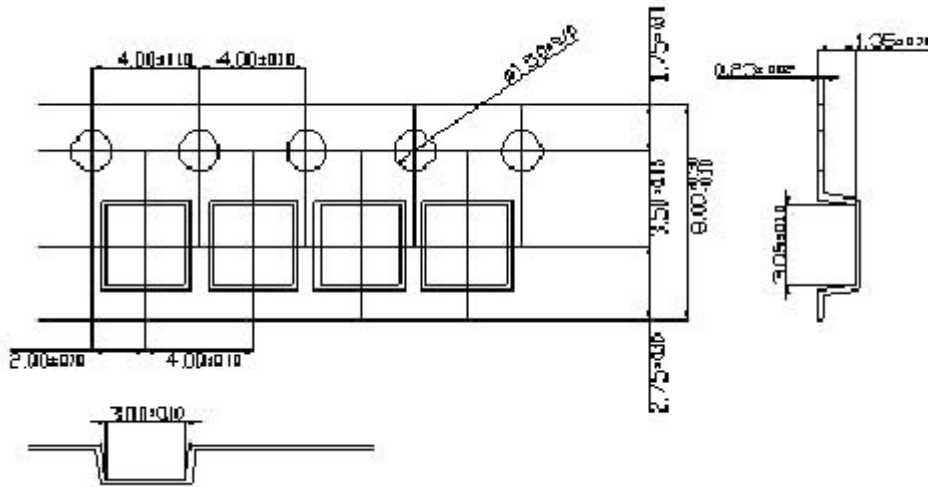

9. External Dimensions of Reel (Unit: mm)

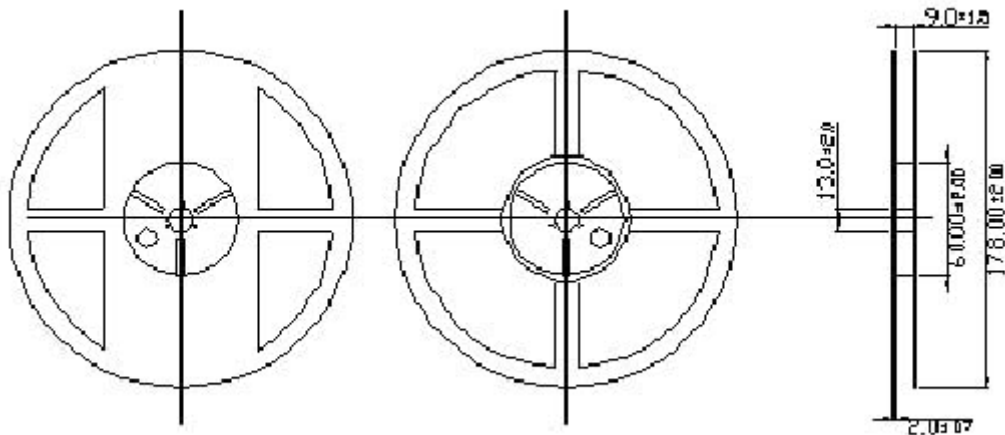

The above reel is made of plastic and is recyclable.

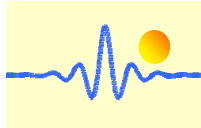

10. RELIABILITY

10.1 TEST CONDITION

	CONDITION
HIGH TEMP. STORAGE	Ta=110°C,t=1000HR
LOW TEMP. STORAGE	Ta=-40°C,t=1000HR
HIGH TEMP. OPERATION	Ta=100°C,Iopr=6mA,t=1000HR
LOW TEMP. OPERATION	Ta=-20°C,Iopr=6mA,t=1000HR
HIGH TEMP. HIGH UMIDITY OPERATION	Ta=60°C, HR=90%,Iopr=9mA,t=1000HR
HUMIDITY	Ta=60°C,HR=90%, t=1000HR
PCT	Ta=121°C,HR=100%, Pv=2atm, t=24HR
THERMAL SHOCK	T(L)=-55°C,T(H)=150°C, t=(L,H)=30min,M=30CYCLE
SOLDERING HEAT RESISTANCE	solder temp=250±5°C, t=10sec,REFLOW
SOLDABILITY	solder temp=230±5°C, t=5sec,dip
TERMINAL STRENGTH	TENSION 300g/30sec
SURGE	V=500V, C=200pF, R=0Ω (test method EIAJ EDX 8503)

10.2 CRITERION FOR JUDGING

After each reliability test, samples should be kept for at least 24 hrs at room temp. & humidity, and then measured.

The change rates should be confined within the ranges as follows.

item	OK SPEC	NG/OK
ΔR_{in}	UNDER $\pm 20\%$	OK (SPEC SATISFYING)
ΔR_{out}	UNDER $\pm 20\%$	
ΔV_H	UNDER $\pm 20\%$	
$\Delta V_o/V_H$	UNDER $\pm 5\%$	